



SAFETY EDGE SWITCHES
E30BK1



Compact Safety Edge Switches

Ensures safety on automatic doors of machine tools
and on small automatic guided vehicles

IDEC CORPORATION

Low profile switches ideal for installation on automatic doors

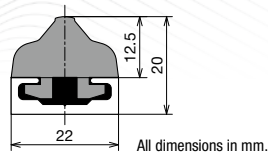

Compliant to **ISO13856-2** Pressure sensitive protective devices standard.

Reduces risk of people being caught between automatic doors.

Oil resistant NBR housing

Suitable for use in harsh environment where oil mist is present.



Joint connection for automatic doors

By attaching an end joint, two safety edge switches can be connected. The ends can also detect contact.

Special product. Contact IDEC for details.

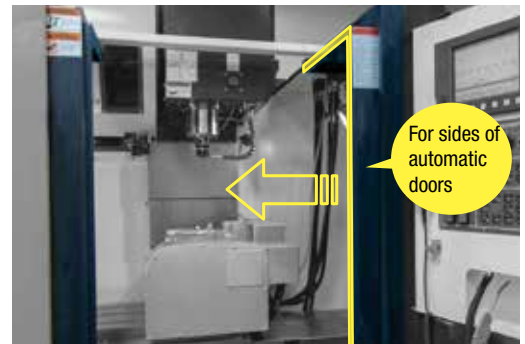
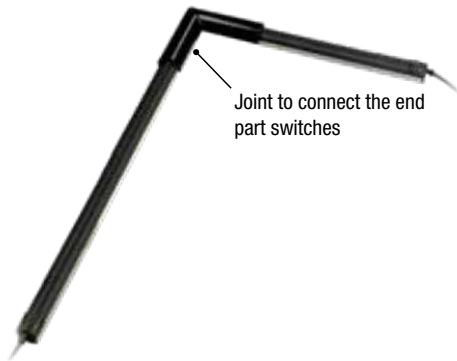

Minimum bending radius of R80 that can fit on small AGVs

*Dimensions on the right is required for R bending model. Note: R part is not compliant to ISO13856-2.

Special product. Contact IDEC for details.

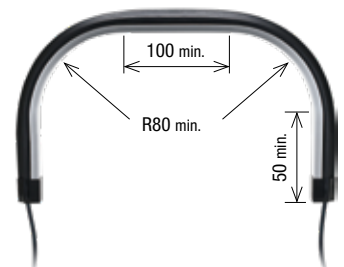

All dimensions in mm.

Select from **Wiring** styles

*Only 4-wire double-sided wiring is available

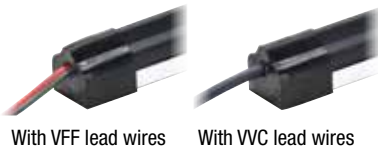

Prevents **bounce-back from bending**
High profile cap type

For AGV (IP46 compliant)



Prevents **oil penetration**
Low profile cap type

For automatic doors (IP66 compliant)

Select from **Mounting** styles

Standard type

No stud bolts

Stud type*

With stud bolts

Stud bolt →

*Stud type is a special product. Contact IDEC for details.

EC type approved product when used in combination with IDEC HR6S-AK safety relay modules

Standards and Approvals

- TÜV NORD approved
- Applicable standards: EN ISO13856-2:2013, EN 12978:2003+A1:2009
- Functional Safety: Category 3, PLd (ISO13849-1)
- The joint area (when connected) is also certified.



See website for details on approvals and standards.



Safety Edge Switches
E30BK1



Safety Relay Modules
HR6S-AK



Expansion Modules
HR6S-EP

Expandable

Removable aluminum channel for easy installation and replacement

The main body of the safety edge switch can easily be mounted on the fixed aluminum channel from the front.

Installation method: Low profile cap type

*For installation details on high profile cap type, refer to the instruction manual.

1 Drill screw holes in the aluminum channel and fix on the installation surface.

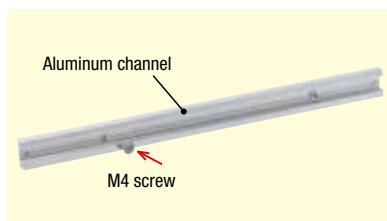

*Mounting screws are not supplied.
 Recommended fixing screw: Low head M5 screw
 Recommended tightening torque: 3.0 N·m

2 Insert the joint part of the aluminum channel of the groove of the sensor unit and push in.

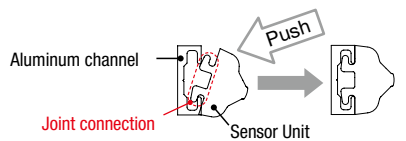

3 Install the stopper on the edges.

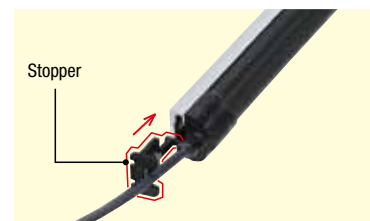

E30BK1 Safety Edge Switches



See website for details on approvals and standards.

E30BK1

Package quantity: 1

Lead wire Type	Lead wire length (mm)	Part No.
VVC	500 for both L/R	E30BK1-500LC-5-5-4
		E30BK1-600LC-5-5-4
		E30BK1-700LC-5-5-4
		E30BK1-800LC-5-5-4
		E30BK1-900LC-5-5-4
		E30BK1-1000LC-5-5-4
		E30BK1-1500LC-5-5-4
		E30BK1-500HC-5-5-4
		E30BK1-600HC-5-5-4
		E30BK1-700HC-5-5-4
		E30BK1-800HC-5-5-4
		E30BK1-900HC-5-5-4
		E30BK1-1000HC-5-5-4
		E30BK1-1500HC-5-5-4
		VFF
E30BK1-600HF-5-5-4		
E30BK1-700HF-5-5-4		
E30BK1-800HF-5-5-4		
E30BK1-1500HF-5-5-4		

Part No. Configuration

E30BK1 - 1000 L C - 5 - 5 - 4

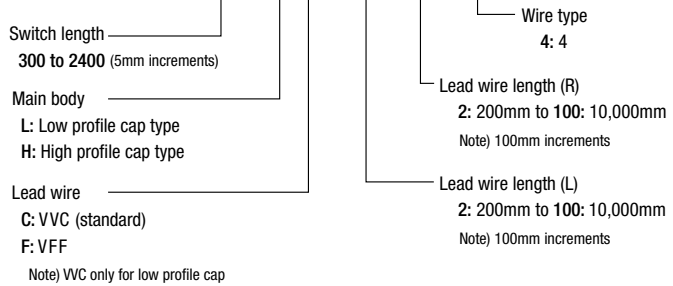

- * For stud model, contact IDEC.
- * For joint connection, contact IDEC.
- * For R type, contact IDEC.

- If the full length or lead wire length other than the above is required, refer to the Part No. Configuration on the right.

Description

Part No.	E30BK1
Dimensions (W x H x D)	22 (aluminum channel) x 20 x 300 to 2,400mm
Weight	Approx. 0.6 kg/m (sensor unit and aluminum channel)
Housing material / color	NBR / Black, Hardness: 70° (Shore durometer type A)
End cap material / color	NBR / Black
Aluminum channel material	Aluminum
Sensor connection	Maximum 24 series connections (maximum total length of lead wires connected together is up to 48m)
Lead wire Type	VFF lead wires Core wire: VFF 0.5mm ² ×2, cable jacket material: PVC (soft) Outer diameter: approx. 2.5 × 5mm
	VVC lead wires Core wire: 2 cores AWG24 × 2, lead wire diameter: approx. 1.2mm Core wire cable jacket material: PVC Outer sheath diameter: approx. ø4.3mm, outer sheath material: PVC
Rated power voltage	AC/DC common use, 5V to 24V±10
Rated current	0.01 to 0.3A±10% (resistive load)
Insulation resistance	100MΩ minimum (250V DC) (at factory setting)
Withstand voltage	250V DC (for 1 minute)
Operating temperature range	0 to +50°C (no freezing)
Storage temperature range	0 to +60°C (with no condensation)
Humidity range	90% RH max.
Protection class	High profile cap type: IP46 / Low profile cap type: IP66
Actuating force	150N maximum (measured with ø80 test piece) (*1)
Pretravel	4m maximum (measured with ø80 test piece) (*1)
Overtravel (*2)	B1: 0.5mm (250N) min., B2: 1.0mm (400N) min. (*See Figure 1.)
Withstand load	600N (measured with ø80 test piece)
Mechanical durability	10,000 times minimum (measured with ø80 test piece)
B10d	100,000 times minimum (ø80 flat surface, 250N)
Detection angle	±20° (*See Figure 2.)
Dead range	End part 30mm
Maximum operating speed	10mm/sec (0 to +50°C)
Installation direction	A, B, C, D (*See Figure 3.)

- *1) Before using this product, be sure to understand the risk assessment of the system.
Design the system according to the operating speed and the weight of the object to be detected.
- *2) Except R-bending part of R type

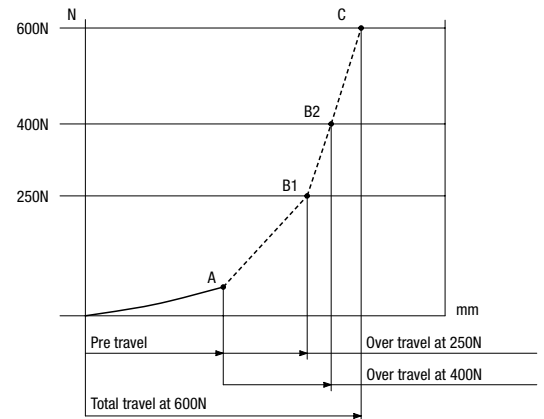

A	Operation load	60N
	Pre travel	2.3mm
B1	Over travel at 250N	1.4mm
B2	Over travel at 400N	1.8mm
C	Total travel at 600N	4.6mm

- The values are obtained from actual measurements. Use the values as a representative value.
- Measured according to ISO 13856-2 regulations.
The measurement conditions are as follows:
Test piece: ø80 Test position: longitudinal center
Operating speed: 10 mm/sec Ambient temperature: 20°C

Figure 1

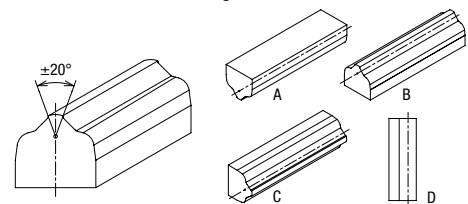

Figure 2

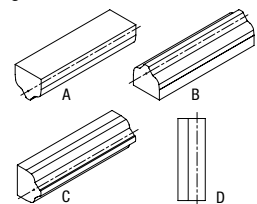

Figure 3

Safety relay module (sold separately)

*See HR6S product catalog for details.

HR6S-AK Safety Relay Module



See website for details on approvals and standards.



Expandable output



Pressure-sensitive switches such as mat switches can be connected

- Protects both the operator and the machine by immediately stopping hazardous motion by receiving a stop instruction from the operator or by detecting failure of the safety circuit itself.
- Pressure-sensitive switches such as mat switches and edge switches can be connected*
- NC contacts are available for output.

When connecting E30BK1, set the function mode to 8.
*See HR6S product catalog for details on start mode.

HR6S-AK Package quantity: 1

Terminal Style	Part No.	Power Supply Voltage
Push-in terminal	HR6S-AK1C	24V AC/DC
Screw terminal	HR6S-AK1P	24V AC/DC

HR6S-EP Expansion Module



See website for details on approvals and standards.



Module for extending safety outputs

- 4NO + 2NC outputs can be expanded.
- When connecting with HR6S-AT, immediate or delayed output can be set with the HR6S-AT change-over switch.

HR6S-EP Package quantity: 1

Terminal Style	Part No.	Power Supply Voltage
Push-in terminal	HR6S-EP1C	24V AC/DC
Screw terminal	HR6S-EP1P	24V AC/DC

Connection diagram

HR6S-AK safety relay module + HR6S-EP expansion module circuit example

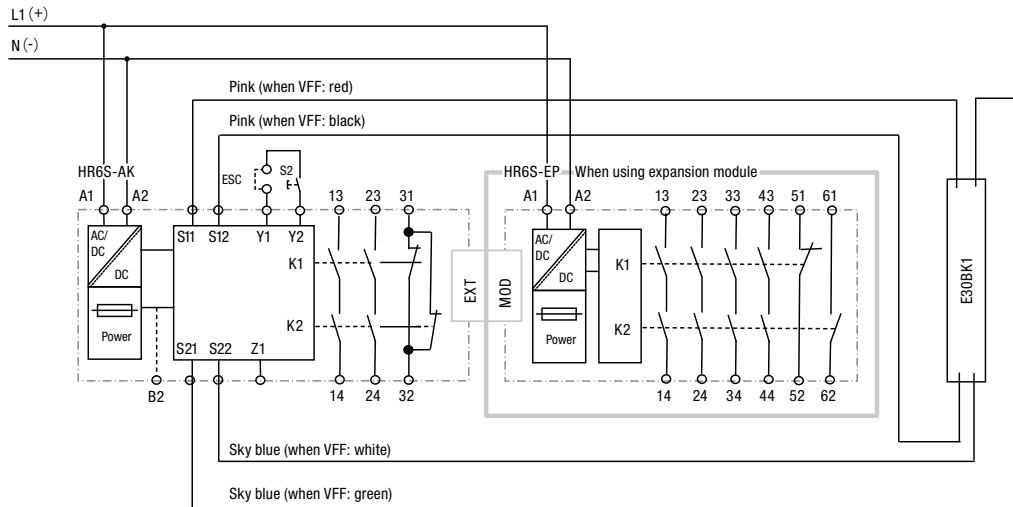

Up to 24 series connection

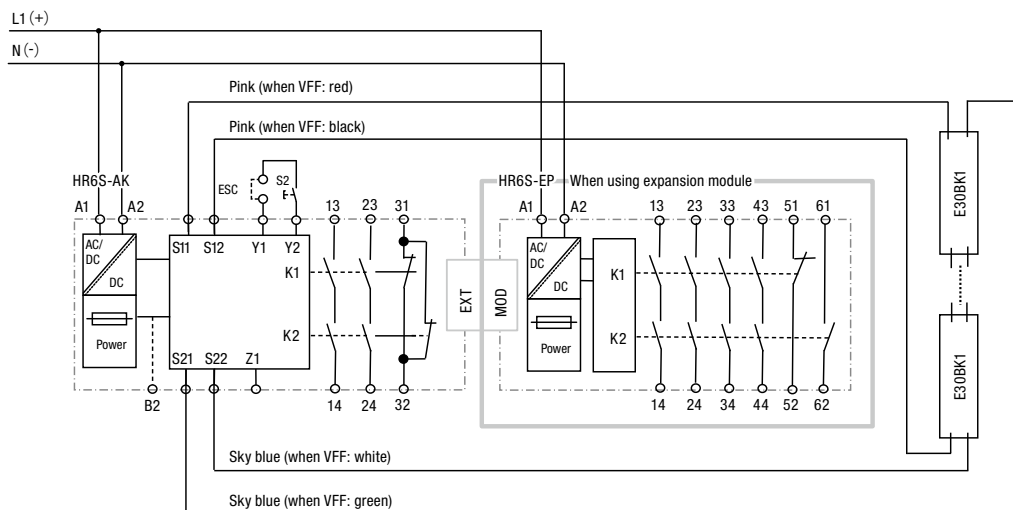

ESC: External start condition
S2: Start switch

Dimensions

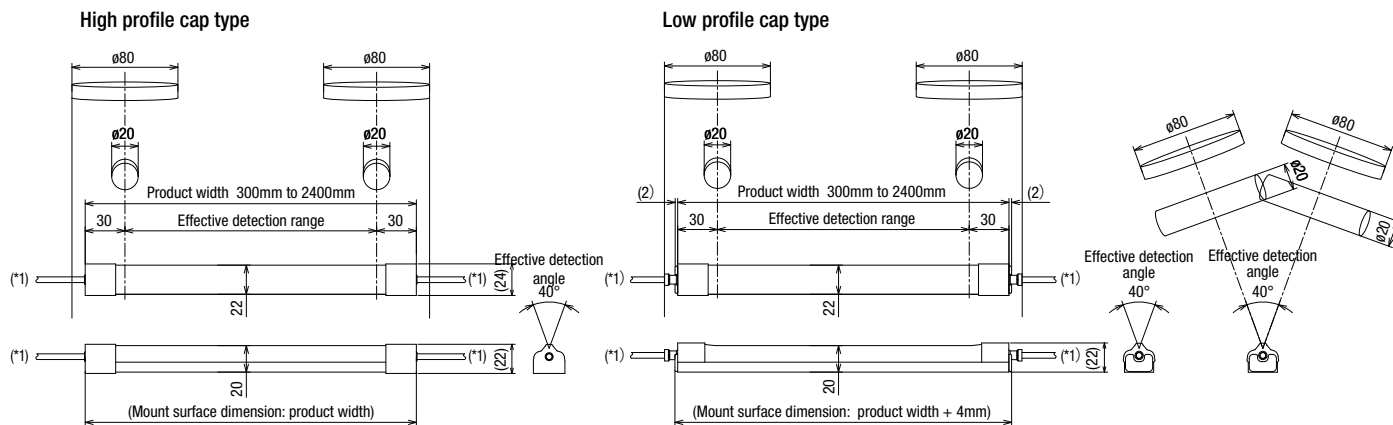

*1) Lead wire length between 200mm and 10,000mm for both left and right. Specify in 100mm increments.

Safety Precautions

- Be sure to observe the following when installing this product. Otherwise, there may be a risk of serious danger to life, body, or property.
- This product is a contact detection switch designed to detect contact or collision by the machine on which it is installed. Improper installation or use may result in loss of functionality or inability to detect contact or collision by the machine in which it is installed. In addition, the expected damage will vary depending on the machine on which it is installed. Before using this product, thoroughly read all instruction manuals, specifications, etc. (product specifications, safety precautions, warnings, and caution labels) of the equipment to which this product is connected.
- We are committed to improving quality and reliability. In the unlikely event that this product is used in an application where failure or damage of the product may cause serious danger to human life, body, or property, be sure to confirm the following before use:
 - (1) "Foolproof design" and "Fail-safe design" is implemented in conjunction with other safety sensors.
 - (2) The product is properly wired and installed for its intended use.
- Design the system and select the product by taking into account the speed and weight of the object to be detected. Depending on the specifications of the product, accidents may be caused due to damage of the product.
- Wiring should be performed with the power turned off to the machine in which the product is to be installed. Also, do not touch the wiring of the machine while it is energized. Failure to do so may result in electric shock or malfunction of connected equipment.
- Resistance to splashes, water and dust is not permanent, and may degrade due to normal abrasion. Do not use the product outdoors, under constant exposure to water, or under high humidity. Otherwise, it may result in the loss of functionality, failure, or malfunction.

Instructions

For details on mounting, wiring, and circuit examples, see the instruction manual from the below URL.
 URL: <https://product.idec.com/?product=E30BK1>



Operating environment

- Use the product within the specified value.

Periodic Inspection/Long-term Use

- The product should be inspected periodically in accordance with the conditions of use. Inspection work should be performed by workers with expertise in consideration of safety.

Product Disposal

- Dispose the product as industrial waste.

Chemical and oil resistance

Alcohol	1	Vegetable oil	1
Strong alkali	1	Organic solvent	3
Ammonium hydroxide	1	Ester solvents	3
Gasoline	1	Ketone solvent (containing oxygen)	3
ASTM oil #1	1	Organic acid	3
ASTM oil #3	2	Ozone	3

1: No impact

2: Significant impact. Refrain from contact.

3: Significant impact. No contact possible.

*The above influence levels do not apply to lead wires.

*Check the impact level in the actual operating environment before use.

Product Information

Large edge switches

E22BK1



No dead zones on the edges.
Straight type large edge switch.

Edge switches

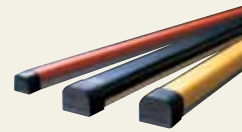

Contact detection switches to prevent damage from contact or collision.
8 types of different structures and sizes to choose from.

Bumper switches



For AGVs and other moving vehicles.
Contact and collision detection with cushioning.

Tape switches

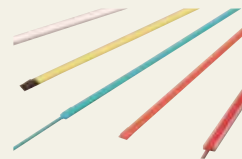

Tape switches to detect collision or contact.

Mat switches



Step-on switch with excellent reliability and durability.

Explosion-proof mat switches

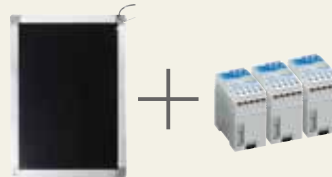

Mat switch to detect access and human presence.
Can be used in an explosive environment.

Safety laser scanners

SE2L



Safety sensors for a wide range of applications.
Distance 5m, sensing angle 270°.

Safety Commander

HT3P



Tablet holder with safety features.
Used on industrial tablets to operate devices such as AGVs.

Interlock switches

HS1T



Suitable for large doors and large equipment.
Solenoid interlock switch with high locking strength.

HS5L



Space-saving, compact interlock switches with solenoid.
Built-in with 2 or 4 contacts.

Ordering Terms and Conditions

Thank you for using IDEC Products.

By purchasing products listed in our catalogs, datasheets, and the like (hereinafter referred to as "Catalogs") you agree to be bound by these terms and conditions. Please read and agree to the terms and conditions before placing your order.

1. Notes on contents of Catalogs

- (1) Rated values, performance values, and specification values of IDEC products listed in this Catalog are values acquired under respective conditions in independent testing, and do not guarantee values gained in combined conditions.
Also, durability varies depending on the usage environment and usage conditions.
- (2) Reference data and reference values listed in Catalogs are for reference purposes only, and do not guarantee that the product will always operate appropriately in that range.
- (3) The specifications / appearance and accessories of IDEC products listed in Catalogs are subject to change or termination of sales without notice, for improvement or other reasons.
- (4) The content of Catalogs is subject to change without notice.

2. Note on applications

- (1) If using IDEC products in combination with other products, confirm the applicable laws / regulations and standards.
Also, confirm that IDEC products are compatible with your systems, machines, devices, and the like by using under the actual conditions. IDEC shall bear no liability whatsoever regarding the compatibility with IDEC products.
- (2) The usage examples and application examples listed in Catalogs are for reference purposes only. Therefore, when introducing a product, confirm the performance and safety of the instruments, devices, and the like before use. Furthermore, regarding these examples, IDEC does not grant license to use IDEC products to you, and IDEC offers no warranties regarding the ownership of intellectual property rights or non-infringement upon the intellectual property rights of third parties.
- (3) When using IDEC products, be cautious when implementing the following.
 - i. Use of IDEC products with sufficient allowance for rating and performance
 - ii. Safety design, including redundant design and malfunction prevention design that prevents other danger and damage even in the event that an IDEC product fails
 - iii. Wiring and installation that ensures the IDEC product used in your system, machine, device, or the like can perform and function according to its specifications
- (4) Continuing to use an IDEC product even after the performance has deteriorated can result in abnormal heat, smoke, fires, and the like due to insulation deterioration or the like. Perform periodic maintenance for IDEC products and the systems, machines, devices, and the like in which they are used.
- (5) IDEC products are developed and manufactured as general-purpose products for general industrial products. They are not intended for use in the following applications, and in the event that you use an IDEC product for these applications, unless otherwise agreed upon between you and IDEC, IDEC shall provide no guarantees whatsoever regarding IDEC products.
 - i. Use in applications that require a high degree of safety, including nuclear power control equipment, transportation equipment (railroads / airplanes / ships / vehicles / vehicle instruments, etc.), equipment for use in outer space, elevating equipment, medical instruments, safety devices, or any other equipment, instruments, or the like that could endanger life or human health
 - ii. Use in applications that require a high degree of reliability, such as provision systems for gas / waterworks / electricity, etc., systems that operate continuously for 24 hours, and settlement systems
 - iii. Use in applications where the product may be handled or used deviating from the specifications or conditions / environment listed in the Catalogs, such as equipment used outdoors or applications in environments subject to chemical pollution or electromagnetic interference
If you would like to use IDEC products in the above applications, be sure to consult with an IDEC sales representative.

3. Inspections

We ask that you implement inspections for IDEC products you purchase without delay, as well as thoroughly keep in mind management/maintenance regarding handling of the product before and during the inspection.

4. Warranty

- (1) Warranty period
The warranty period for IDEC products shall be one (1) year after purchase or delivery to the specified location. However, this shall not apply in cases where there is a different specification in the Catalogs or there is another agreement in place between you and IDEC.
- (2) Warranty scope
Should a failure occur in an IDEC product during the above warranty period for reasons attributable to IDEC, then IDEC shall replace or repair that product, free of charge, at the purchase location / delivery location of the product, or an IDEC service base. However, failures caused by the following reasons shall be deemed outside the scope of this warranty.
 - i. The product was handled or used deviating from the conditions / environment listed in the Catalogs
 - ii. The failure was caused by reasons other than an IDEC product
 - iii. Modification or repair was performed by a party other than IDEC
 - iv. The failure was caused by a software program of a party other than IDEC
 - v. The product was used outside of its original purpose
 - vi. Replacement of maintenance parts, installation of accessories, or the like was not performed properly in accordance with the user's manual and Catalogs
 - vii. The failure could not have been predicted with the scientific and technical standards at the time when the product was shipped from IDEC
 - viii. The failure was due to other causes not attributable to IDEC (including cases of force majeure such as natural disasters and other disasters)
 Furthermore, the warranty described here refers to a warranty on the IDEC product as a unit, and damages induced by the failure of an IDEC product are excluded from this warranty.

5. Limitation of liability

The warranty listed in this Agreement is the full and complete warranty for IDEC products, and IDEC shall bear no liability whatsoever regarding special damages, indirect damages, incidental damages, or passive damages that occurred due to an IDEC product.

6. Service scope

The prices of IDEC products do not include the cost of services, such as dispatching technicians. Therefore, separate fees are required in the following cases.

- (1) Instructions for installation / adjustment and accompaniment at test operation (including creating application software and testing operation, etc.)
- (2) Maintenance inspections, adjustments, and repairs
- (3) Technical instructions and technical training
- (4) Product tests or inspections specified by you

The above content assumes transactions and usage within your region. Please consult with an IDEC sales representative regarding transactions and usage outside of your region. Also, IDEC provides no guarantees whatsoever regarding IDEC products sold outside your region.

IDEC CORPORATION

Head Office 6-64, Nishi-Miyahara-2-Chome, Yodogawa-ku, Osaka 532-0004, Japan

USA	IDEC Corporation	Singapore	IDEC Izumi Asia Pte. Ltd.
EMEA	APEM SAS	Thailand	IDEC Asia (Thailand) Co., Ltd.
		India	IDEC Controls India Private Ltd.

 www.idec.com

China	IDEC (Shanghai) Corporation	Japan	IDEC Corporation
	IDEC Izumi (H.K.) Co., Ltd.		
Taiwan	IDEC Taiwan Corporation		

Specifications and other descriptions in this brochure are subject to change without notice.
Information in this brochure is current as of March, 2022.

© 2022 IDEC Corporation, All Rights Reserved.

EP1767-0

